

Rectangular Photoelectric Sensor



BJ Series (Cable type) PRODUCT MANUAL

For your safety, read and follow the considerations written in the instruction manual, other manuals and Autonics website.

The specifications, dimensions, etc. are subject to change without notice for product improvement. Some models may be discontinued without notice.

Features

- Compact size: W 10.6 × H 32 × L 20 mm
- IP65 protection rating (IEC standard)
- Adjuster for selecting Light ON/Dark ON mode
- Built-in sensitivity adjustment adjuster (except BJG30-DDT)
- Reverse power protection circuit, output short overcurrent protection circuit
- Mutual interference prevention function (except through-beam and BGS reflective type)
- Excellent noise immunity and minimal influence from ambient light

Safety Considerations

- Observe all 'Safety Considerations' for safe and proper operation to avoid hazards.
- ⚠ symbol indicates caution due to special circumstances in which hazards may occur.

⚠ Warning Failure to follow instructions may result in serious injury or death.

- 01. Fail-safe device must be installed when using the unit with machinery that may cause serious injury or substantial economic loss. (e.g., nuclear power control, medical equipment, ships, vehicles, railways, aircraft, combustion apparatus, safety equipment, crime/disaster prevention devices, etc.)**
Failure to follow this instruction may result in personal injury, economic loss or fire.
- 02. Do not use the unit in the place where flammable/explosive/corrosive gas, high humidity, direct sunlight, radiant heat, vibration, impact or salinity may be present.**
Failure to follow this instruction may result in explosion or fire.
- 03. Do not disassemble or modify the unit.**
Failure to follow this instruction may result in fire.
- 04. Do not connect, repair, or inspect the unit while connected to a power source.**
Failure to follow this instruction may result in fire.
- 05. Check 'Connections' before wiring.**
Failure to follow this instruction may result in fire.

⚠ Caution Failure to follow instructions may result in injury or product damage.

- 01. Use the unit within the rated specifications.**
Failure to follow this instruction may result in fire or product damage.
- 02. Use a dry cloth to clean the unit, and do not use water or organic solvent.**
Failure to follow this instruction may result in fire.

Cautions during Use

- Follow instructions in 'Cautions during Use'. Otherwise, It may cause unexpected accidents.
- When connecting an inductive load such as DC relay or solenoid valve to the output, remove surge by using diodes or varistors.
- Use the product after 0.5 sec of the power input.
When using a separate power supply for the sensor and load, supply power to the sensor first.
- 12-24 VDC= power supply should be insulated and limited voltage/current or Class 2, SELV power supply device.
- Wire as short as possible and keep it away from high voltage lines or power lines to prevent surge and inductive noise.
- When using switching mode power supply (SMPS), ground F.G. terminal and connect a condenser between 0V and F.G. terminal to remove noise.
- When using a sensor with a noise-generating equipment (e.g., switching regulator, inverter, and servo motor), ground F.G. terminal of the equipment.
- This unit may be used in the following environments.
 - Indoors (in the environment condition rated in 'Specifications')
 - Altitude max. 2,000 m
 - Pollution degree 3
 - Installation category II

Product Components

Sensing type	Through-beam	Polarized retroreflective	Diffuse reflective	BGS reflective	Narrow beam reflective
Product components	Product, instruction manual				
Reflector	-	MS-2A	-	-	-
Adjustment screwdriver	× 1	× 1	× 1	× 1	× 1
Bracket A	× 2	× 1	× 1	× 1	× 1
M3 bolt / nut	× 4	× 2	× 2	× 2	× 2

Ordering Information

This is only for reference, the actual product does not support all combinations. For selecting the specified model, follow the Autonics website.

BJ ① ② - ③ **D T** - ④

① Feature

No mark: General type
 G: Transparent glass sensing type (Diffuse reflective type)
 N: Micro spot type (Narrow beam reflective type)

③ Sensing type

T: Through-beam
 P: Polarized retroreflective
 D: Diffuse reflective
 B: BGS reflective
 N: Narrow beam reflective

② Sensing distance

Number: Sensing distance (unit: mm)
 Number+M: Sensing distance (unit: m)

④ Control output

No mark: NPN open collector output
 P: PNP open collector output

Sold Separately

- Reflector: MS Series
- Retroreflective tape: MST Series
- Bracket B: BJ BRACKET B

Cautions during Installation

- Be sure to install this product by following the usage environment, location, and specified ratings. Consider the listed conditions below.
 - Installation environment and background (reflected light)
 - Sensing distance and sensing target
 - Direction of target's movement
 - Feature data
- When installing multiple sensors closely, it may result in malfunction due to mutual interference.
- BGS reflective: If the sensing target has a glossy surface or high reflection, tilt the sensor with an angle from 5 to 10 degrees and install it. Get rid of the effect of background object on the sensing performance.
- Narrow beam reflective: Mount the sensor tilted at an angle from 0 to 15 degrees for stable copper wire detection.

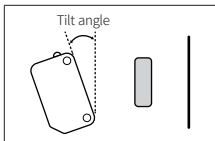

- For installation, tighten the screw with a torque of 0.5 N·m. Mount the brackets correctly to prevent the twisting of the sensor's optical axis.
- Do not impact with a hard object or bend the cable excessively. That could decrease the product's water resistance.
- Use this product after the test. Check whether the indicator works appropriately for the positions of the detectable object.

Through-beam	Retroreflective	Reflective
Emitter - Receiver: Install to face each other	Sensor - Reflector: At least 0.1 m apart, install to face each other (parallel with the sensing side of the unit)	Sensor - Sensing target: Install to face each other (parallel with the sensing side of the unit) BGS reflective: Recommend horizontal / back and force movements of sensing target

Setting Operation Mode

- Be sure to set the mode before power-on.
- Use the offered adjustment screwdriver. Do NOT turn with excessive force to prevent product damage.

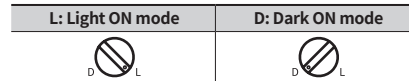

Operation Timing Chart

■ Light ON mode

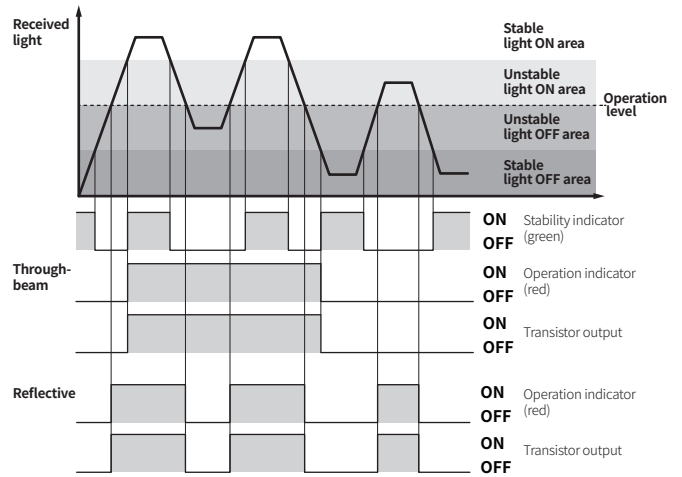

- In Dark ON mode, the waveforms are reversed.
- Operation indicator and transistor output differ from the sensing method.

Connections

■ Emitter

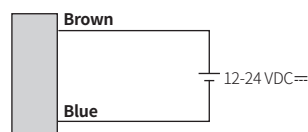

■ Receiver, Polarized retroreflective/Diffuse/BGS/ Narrow beam reflective type

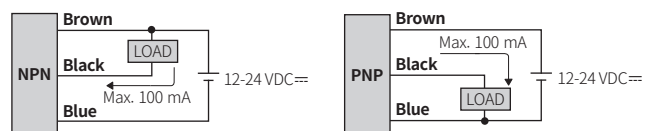

Circuit

■ NPN open collector output

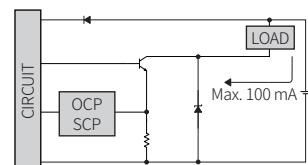

■ PNP open collector output

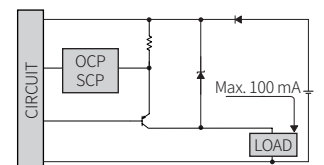

- OCP (over current protection), SCP (short circuit protection)
- If short-circuit the control output terminal or supply current over the rated specification, normal control signal is not output due to the protection circuit.

Sensitivity Adjustment

- Set the adjuster for stable Light ON area, minimizing the effect of the installation environment.
- Use the offered adjustment screwdriver. Do NOT turn with excessive force to prevent product damage.
- The steps below are based on Light ON mode.

STEP	Status	Description
01	Received	Turn the adjuster from MIN to MAX sensitivity and check the position (A) where the operation indicator activates under the light ON area.
02	Interrupted	Turn the adjuster from (A) to MAX and check the position (B) where the operation indicator activates under the light OFF area. If the operation indicator does NOT activate at the MAX (maximum sensitivity): MAX = (B).
03	-	Set the adjuster at the mid position between (A) and (B) for optimal sensitivity.

Dimensions

- Unit: mm, For the detailed drawings, follow the Autonics website.

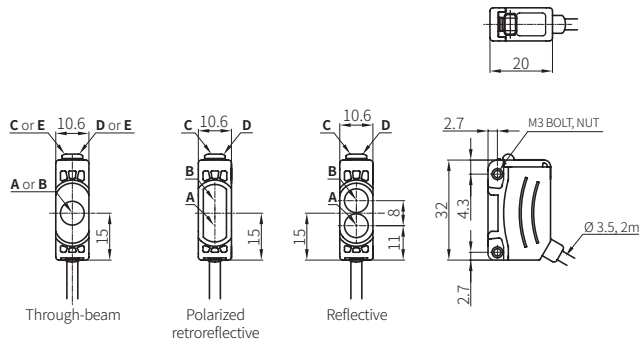

A	Optical axis of emitter	D	Stability indicator (green)
B	Optical axis of receiver	E	Power indicator of emitter (green)
C	Operation indicator (red)		

■ Reflector (MS-2A)

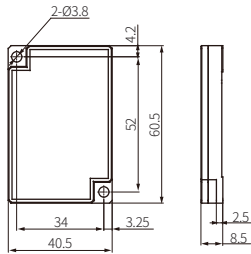

■ Bracket A

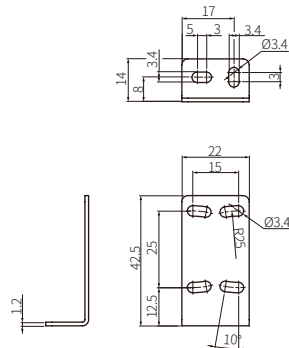

Specifications

Model	BJ□-TDT-□	BJ3M-PDT-□	BJ□-BDT-□	BJN□-NDT-□
Sensing type	Through-beam	Polarized retroreflective	BGS reflective	Narrow beam reflective
Sensing distance	7 m 10 m 15 m	3 m ⁽⁰¹⁾	10 to 30 mm ⁽⁰²⁾ 10 to 50 mm ⁽⁰³⁾	30 to 70 mm ⁽⁰⁴⁾ 70 to 130 mm ⁽⁰⁵⁾
Sensing target	Opaque materials	Opaque materials	Opaque materials, translucent materials	Opaque materials, translucent materials
Min. sensing target	≥ Ø8 mm ≥ Ø12 mm	≥ Ø75 mm	-	≥ Ø0.2 mm (copper wire)
Hysteresis	-	-	≤ 10% of sensing distance	≤ 25% of sensing distance ≤ 20% of sensing distance
Black/white difference	-	-	≤ 10% of sensing distance	-
Response time	≤ 1 ms	≤ 1 ms	≤ 1.5 ms	≤ 1 ms
Light source	Red Red Infrared	Red	Red	Red
Peak emission wavelength	650 nm 660 nm 850 nm	660 nm	660 nm	650 nm
Min. spot size	-	-	≈ Ø5.0 mm ≈ Ø4.5 mm	≈ Ø2.0 mm ≈ Ø2.5 mm
Sensitivity adjustment	YES (Adjuster)	YES (Adjuster)	YES (Adjuster) ⁽⁰⁴⁾	YES (Adjuster)
Mutual interference prevention	-	YES	-	YES
Operation mode	Light ON mode - Dark ON mode selectable (Adjuster)			
Indicator	Operation indicator (red), stability indicator (green), power indicator (green) ⁽⁰⁵⁾			
Approval	CE ENEC	CE ENEC	CE ENEC	CE ENEC
Unit weight (packaged)	≈ 90 g (≈ 115 g)	≈ 60 g (≈ 85 g)	≈ 50 g	≈ 45 g

01) Reflector (MS-2A)

02) Non-glossy white paper 50 × 50 mm

03) Non-glossy white paper 100 × 100 mm

04) -10% of max. sensing distance, Non-glossy white paper

05) Only for the emitter

Model	BJ□-DDT-□	BJG30-DDT
Sensing type	Diffuse reflective	Diffuse reflective
Sensing distance	100 mm ⁽⁰¹⁾ 300 mm ⁽⁰²⁾ 1 m ⁽⁰³⁾	15 mm ⁽⁰³⁾ or 30 mm ⁽⁰¹⁾
Sensing target	Opaque materials, translucent materials	Transparent glass or opaque materials, translucent materials
Hysteresis	≤ 20% of sensing distance	≤ 20% of sensing distance
Response time	≤ 1 ms	≤ 1 ms
Light source	Infrared Red Infrared	Infrared
Peak emission wavelength	850 nm 660 nm 850 nm	850 nm
Sensitivity adjustment	YES (Adjuster)	-
Mutual interference prevention	YES	YES
Operation mode	Light ON mode - Dark ON mode selectable (Adjuster)	Light ON
Indicator	Operation indicator (red), stability indicator (green)	Operation indicator (red), stability indicator (green)
Approval	CE ENEC	CE ENEC
Unit weight (packaged)	≈ 45 g (≈ 70 g)	≈ 45 g

01) Non-glossy white paper 100 × 100 mm

02) Non-glossy white paper 300 × 300 mm

03) Transparent Glass 50 × 50 mm, t = 3.0 mm

Power supply	12-24 VDC≐ ±10% (ripple P-P: ≤ 10%)
Current consumption	It depends on the sensing type
Through-beam	Emitter: ≤ 20 mA, receiver: ≤ 20 mA
Reflective	≤ 30 mA
Control output	NPN open collector output / PNP open collector output model
Load voltage	≤ 26.4 VDC≐
Load current	≤ 100 mA
Residual voltage	NPN: ≤ 1 VDC≐, PNP: ≤ 2.5 VDC≐ (BGS reflective type: ≤ 2 VDC≐)
Protection circuit	Reverse power protection circuit, output short overcurrent protection circuit
Insulation resistance	≥ 20 MΩ (500 VDC≐ megger)
Noise immunity	±240 VDC≐ the square wave noise (pulse width: 1 μs) by the noise simulator
Dielectric strength	1,000 VAC~50/60 Hz for 1 min
Vibration	1.5 mm double amplitude at frequency of 10 to 55 Hz (for 1 min) in each X, Y, Z direction for 2 hours
Shock	500 m/s ² (≈ 50 G) in each X, Y, Z direction for 3 times
Ambient illuminance (receiver)	Sunlight: ≤ 11,000 lx, incandescent lamp: ≤ 3,000 lx
Ambient temperature	-25 to 55 °C, storage: -40 to 70 °C (no freezing or condensation)
Ambient humidity	35 to 85 %RH, storage: 35 to 85 %RH (no freezing or condensation)
Protection rating	IP65 (IEC standard)
Connection	Cable type
Cable spec.	Ø 3.5 mm, 3-wire (emitter: 2-wire), 2 m
Wire spec.	AWG24 (0.08 mm, 40-core), insulator outer diameter: Ø 1 mm
Material	Case: PC+ABS, CAP: PC, sensing part: PMMA, bracket: SUS304, bolt: SCM, nut: SCM, sleeve: Brass, Ni-plate

Sold Separately: Bracket B (BJ BRACKET B)

• Unit: mm, For the detailed drawings, follow the Autonics website.

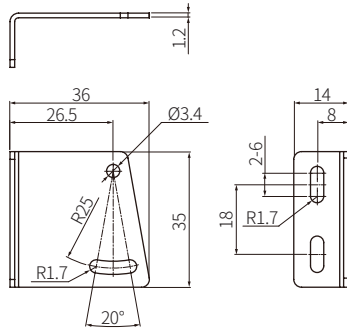

Feature Data: Through-beam Type

Sensing area

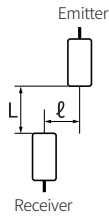

• BJ7M-TDT

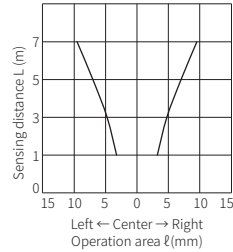

• BJ15M-TDT

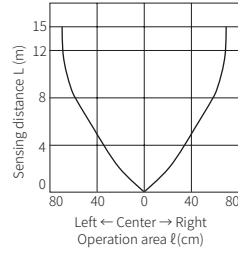

• BJ10M-TDT

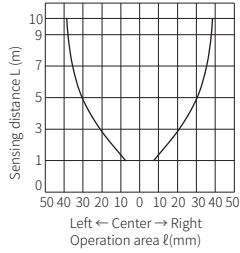

Emitter angle

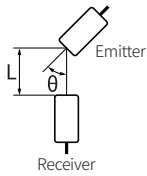

• BJ7M-TDT

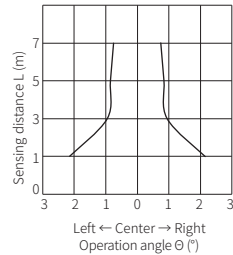

• BJ15M-TDT

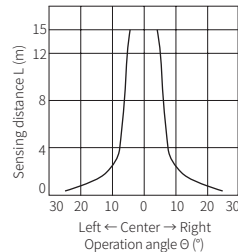

• BJ10M-TDT

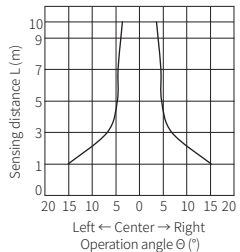

Feature Data: Polarized Retroreflective Type

Sensing area

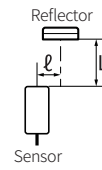

• BJ3M-PDT

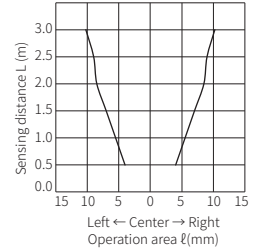

Sensor angle

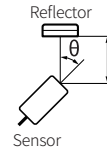

• BJ3M-PDT

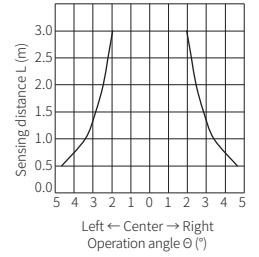

Reflector angle

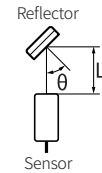

• BJ3M-PDT

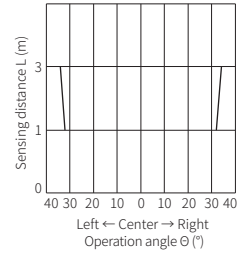

Feature Data: BGS Reflective Type

■ Sensing area

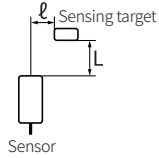

• BJ30-BDT

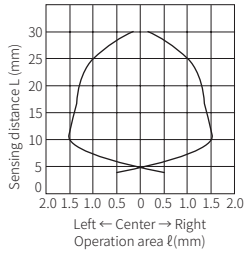

• BJ50-BDT

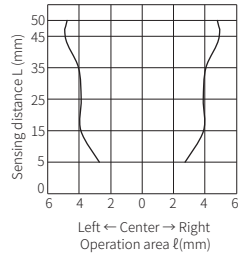

■ Sensing distance by material

• BJ30-BDT

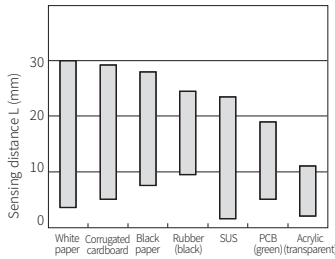

• BJ50-BDT

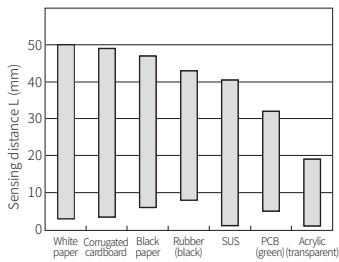

■ Sensing distance by colored paper

• BJ30-BDT

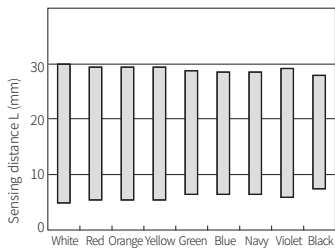

• BJ50-BDT

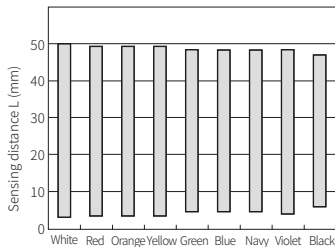

Feature Data: Narrow Beam Reflective Type

■ Sensing area

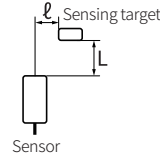

• BJN50-NDT

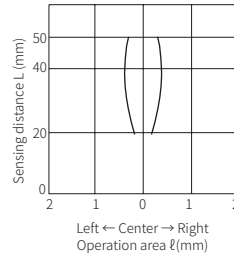

• BJN100-NDT

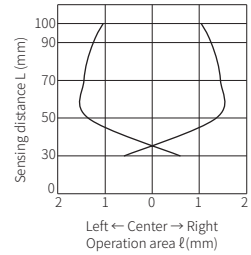

Feature Data: Diffuse Reflective Type

■ Sensing area

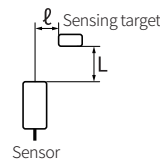

• BJ100-DDT

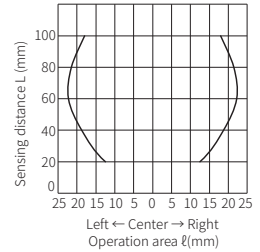

• BJ300-DDT

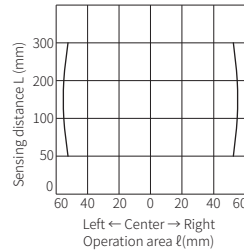

• BJ1M-DDT

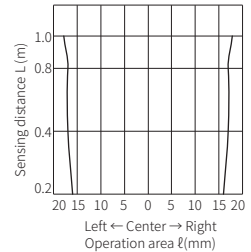

• BJG30-DDT

