

50 mm Diameter Incremental Rotary Encoders



E50 Series PRODUCT MANUAL

For your safety, read and follow the considerations written in the instruction manual, other manuals and Autonics website.

The specifications, dimensions, etc. are subject to change without notice for product improvement. Some models may be discontinued without notice.

Features

- Ø 50 mm housing, Ø 8 mm solid shaft
- Accurate measurement of angle, position, revolution, speed, acceleration, and distance
- Cable type, cable connector type, axial / radial connector types available
- Various resolutions: 1 to 8000 pulses per revolution
- Various control output options
- Power supply: 5 VDC \pm 5%, 12 - 24 VDC \pm 5%

Safety Considerations

- Observe all 'Safety Considerations' for safe and proper operation to avoid hazards.
- ⚠ symbol indicates caution due to special circumstances in which hazards may occur.

⚠ Warning Failure to follow instructions may result in serious injury or death.

- 01. Fail-safe device must be installed when using the unit with machinery that may cause serious injury or substantial economic loss. (e.g. nuclear power control, medical equipment, ships, vehicles, railways, aircraft, combustion apparatus, safety equipment, crime / disaster prevention devices, etc.)**
Failure to follow this instruction may result in personal injury, economic loss or fire.
- 02. Do not use the unit in the place where flammable / explosive / corrosive gas, high humidity, direct sunlight, radiant heat, vibration, impact or salinity may be present.**
Failure to follow this instruction may result in explosion or fire.
- 03. Install on a device panel to use.**
Failure to follow this instruction may result in fire.
- 04. Do not connect, repair, or inspect the unit while connected to a power source.**
Failure to follow this instruction may result in fire.
- 05. Check 'Connections' before wiring.**
Failure to follow this instruction may result in fire.
- 06. Do not disassemble or modify the unit.**
Failure to follow this instruction may result in fire.

⚠ Caution Failure to follow instructions may result in injury or product damage.

- 01. Use the unit within the rated specifications.**
Failure to follow this instruction may result in fire or product damage.
- 02. Do not short the load.**
Failure to follow this instruction may result in fire.
- 03. Do not use the unit near the place where there is the equipment which generates strong magnetic force or high frequency noise and strong alkaline, strong acidic exists.**
Failure to follow this instruction may result in product damage.

Cautions during Use

- Follow instructions in 'Cautions during Use'.
Otherwise, it may cause unexpected accidents.
- 5 VDC \pm 5%, 12 - 24 VDC \pm 5% power supply should be insulated and limited voltage / current or Class 2, SELV power supply device.
- For using the unit with the equipment which generates noise (switching regulator, inverter, servo motor, etc.), ground the shield wire to the F.G. terminal.
- Ground the shield wire to the F.G. terminal.
- When supplying power with SMPS, ground the F.G. terminal and connect the noise canceling capacitor between the 0 V and F.G. terminals.
- Wire as short as possible and keep away from high voltage lines or power lines, to prevent inductive noise.
- For Line driver unit, use the twisted pair wire which is attached seal and use the receiver for RS-422A communication.
- Check the wire type and response frequency when extending wire because of distortion of waveform or residual voltage increment etc. by line resistance or capacity between lines.
- This unit may be used in the following environments.
 - Indoors (in the environment condition rated in 'Specifications')
 - Altitude max. 2,000 m
 - Pollution degree 2
 - Installation category II

Cautions during Installation

- Install the unit correctly with the usage environment, location, and the designated specifications.
- Do not load overweight on the shaft.
- Do not put strong impact when insert a coupling into shaft.
Failure to follow this instruction may result in product damage.
- When fixing the product or coupling with a wrench, tighten under 0.15 N m.
- If the coupling error (parallel misalignment, angular misalignment) between the shaft increases while installation, the life cycle of the coupling and the encoder can be shorten.
- Do not apply tensile strength over 30 N to the cable.

Ordering Information

This is only for reference, the actual product does not support all combinations. For selecting the specified model, follow the Autonics website.

E50 S 8 - ① - ② - ③ - ④ - ⑤

① Resolution

Number: Refer to resolution in 'Specifications'

② Output phase

2: A, B

3: A, B, Z

4: A, \bar{A} , B, \bar{B}

6: A, \bar{A} , B, \bar{B} , Z, \bar{Z}

③ Control output

T: Totem pole output

N: NPN open collector output

V: Voltage output

L: Line driver output

④ Power supply

5: 5 VDC \pm 5%

24: 12 - 24 VDC \pm 5%

⑤ Connection

No mark: Axial cable type

C: Axial cable connector type

CR: Axial connector type

CS: Radial connector type

Product Components

- Product
- Bolt \times 7
- Instruction manual
- Coupling \times 1
- Bracket \times 1

Sold Separately

- Connector cable: CID6S-□, CID9S-□

Connections

- Unused wires must be insulated.
- The metal case and shield cable of encoders must be grounded (F.G.).
- F.G. (Frame Ground) must be grounded separately.

■ Totem pole / NPN open collector / Voltage output

| Pin | Color | Function | Pin | Color | Function |
|-----|--------|----------|-----|--------|----------|
| 1 | Black | OUT A | 4 | Brown | +V |
| 2 | White | OUT B | 5 | Blue | GND |
| 3 | Orange | OUT Z | 6 | Shield | F.G. |

• M17 6-pin layout

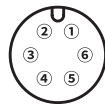

■ Line driver output

| Pin | Color | Function | Pin | Color | Function |
|-----|-------|---------------|-----|--------|---------------|
| 1 | Black | OUT A | 5 | White | OUT B |
| 2 | Red | OUT \bar{A} | 6 | Gray | OUT \bar{B} |
| 3 | Brown | +V | 7 | Orange | OUT Z |
| 4 | Blue | GND | 8 | Yellow | OUT \bar{Z} |
| — | — | — | 9 | Shield | F.G. |

• M17 9-pin layout

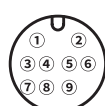

Inner Circuit

- Output circuits are identical for all output phase.

■ Totem pole output

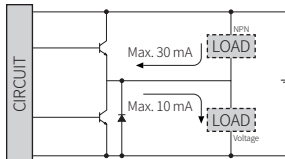

■ NPN open collector output

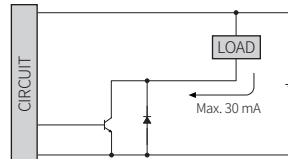

■ Voltage output

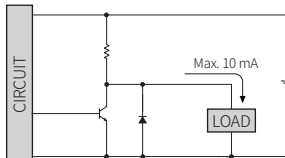

■ Line driver output

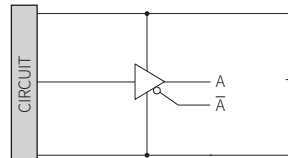

Output Waveform

- The rotation direction is based on facing the shaft, and it is clockwise (CW) when rotating to the right.
- Phase difference between A and B: $\frac{T}{4} \pm \frac{T}{8}$ (T = 1 cycle of A)

■ Totem pole / NPN open collector / Voltage output

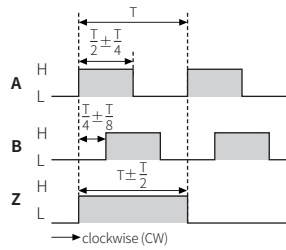

■ Line driver output

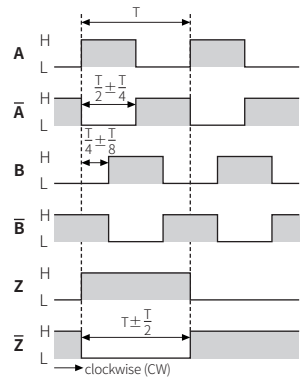

Specifications

| Model | E50S8-□-□-□-□-□-□ | E50S8-□-□-□-□-□-□ | E50S8-□-□-□-□-□-□ | E50S8-□-□-□-□-□-□ |
|---|---|---------------------------|----------------------|--|
| Resolution | 1/2/5 PPR ⁰¹⁾ 10 to 8,000 PPR model | | | |
| Control output | Totem pole output | NPN open collector output | Voltage output | Line driver output |
| Output phase | A, B, Z | A, B, Z | A, B, Z | A, \bar{A} , B, \bar{B} , Z, \bar{Z} |
| Inflow current | \leq 30 mA | \leq 30 mA | - | \leq 20 mA |
| Residual voltage | \leq 0.4 VDC \pm | \leq 0.4 VDC \pm | \leq 0.4 VDC \pm | \leq 0.5 VDC \pm |
| Outflow current | \leq 10 mA | - | \leq 10 mA | \leq -20 mA |
| Output voltage (5 VDC \pm) | \geq (power supply -2.0) VDC \pm | - | - | \geq 2.5 VDC \pm |
| Output voltage (12 - 24 VDC \pm) | \geq (power supply -3.0) VDC \pm | - | - | \geq (power supply -3.0) VDC \pm |
| Response speed ⁰²⁾ | \leq 1 μ s | | | \leq 0.5 μ s |
| Max. response freq. | 300 kHz | | | |
| Max. allowable revolution ⁰³⁾ | 5,000 rpm | | | |
| Approval | CE EAC | CE EAC | CE EAC | CE EAC |

01) Depending on the control output, only A, B or \bar{A} , \bar{B} are output.

02) Based on cable length: 2 m, I sink: 20 mA

03) Select resolution to satisfy Max. allowable revolution \geq Max. response revolution

$$[\text{max. response revolution (rpm)}] = \frac{\text{max. response frequency}}{\text{resolution}} \times 60 \text{ sec}$$

| Connection | Axial cable type | Axial cable connector type | Axial connector type | Radial connector type |
|-------------------------------|--|----------------------------|------------------------------------|---|
| Starting torque | \leq 0.007 N m | | | \leq 0.078 N m |
| Inertia moment | \leq 80 g \cdot cm ² (8×10^{-6} kg \cdot m ²) | | | \leq 400 g \cdot cm ² (4×10^{-5} kg \cdot m ²) |
| Allowable shaft load | Radial: \leq 10 kgf, Thrust: \leq 2.5 kgf | | | |
| Unit weight (packaged) | \approx 275 g (\approx 363 g) | | \approx 180 g (\approx 268 g) | |

| | |
|------------------------------|---|
| Power supply | 5 VDC \pm 5% (ripple P-P: \leq 5%) / 12 - 24 VDC \pm 5% (ripple P-P: \leq 5%) model |
| Current consumption | Totem pole, NPN open collector, Voltage output: \leq 80 mA (no load) Line driver output: \leq 50 mA (no load) |
| Insulation resistance | Between all terminals and case: \geq 100 M Ω (500 VDC \pm megger) |
| Dielectric strength | Between all terminals and case: 750 VAC \sim 50 / 60 Hz for 1 minute |
| Vibration | 1 mm double amplitude at frequency 10 to 55 Hz (for 1 minute) in each X, Y, Z direction for 2 hours |
| Shock | \leq 75 G |
| Ambient temp. | -10 to 70 $^{\circ}$ C, storage: -25 to 85 $^{\circ}$ C (no freezing or condensation) |
| Ambient humi. | 35 to 85%RH, storage: 35 to 90%RH (no freezing or condensation) |
| Protection rating | Axial cable type / cable connector type: IP50 (IEC standard) ⁰¹⁾ Axial / Radial connector type: IP64 (IEC standard) |
| Cable spec. | \varnothing 5 mm, 5-wire (Line driver output: 8-wire), shield cable cable type: 2 m, cable connector type: 250 mm |
| Wire spec. | AWG24 (0.08 mm, 40-core), insulator diameter: \varnothing 1 mm |
| Connector spec. | Totem pole, NPN open collector, Voltage output: M17 6-pin socket type Line driver output: M17 9-pin socket type |

01) Protection structure IP64 option is also available to order.

(starting torque: \leq 0.078 N m, inertia moment: \leq 400 g \cdot cm² (4×10^{-5} kg \cdot m²))

Dimensions

- Unit: mm, For the detailed drawings, follow the Autonics website.
 - Following items are based on cable type, connector type.
- Refer to 'Specifications' for detailed specifications of cable, wire and connector.

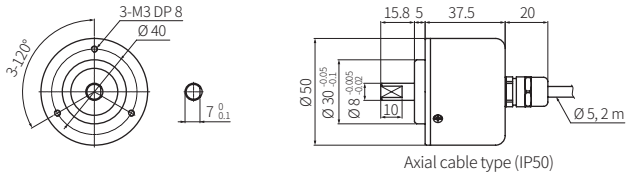

Axial cable type (IP50)

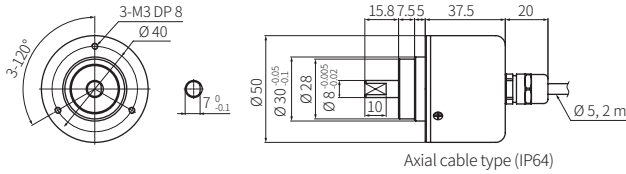

Axial cable type (IP64)

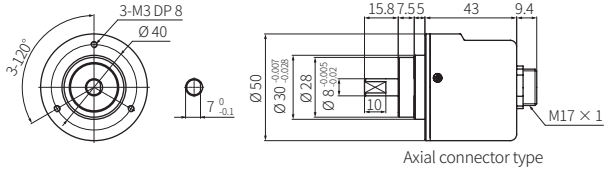

Axial connector type

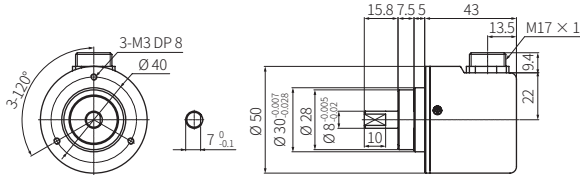

Radial connector type

■ Bracket

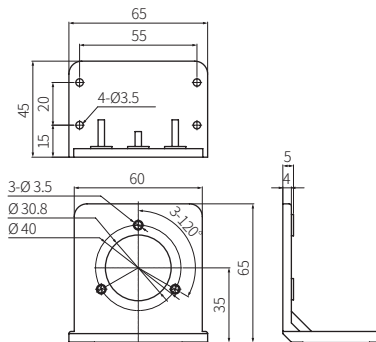

■ Coupling

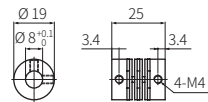

- Parallel misalignment: ≤ 0.25 mm
- Angular misalignment: $\leq 5^\circ$
- End-play: ≤ 0.5 mm