

# Single Display PID Temperature Controllers



## TC Series PRODUCT MANUAL

For your safety, read and follow the considerations written in the instruction manual, other manuals and Autonics website.

The specifications, dimensions, etc are subject to change without notice for product improvement. Some models may be discontinued without notice.

### Features

- Single digital display (switch between PV and SV)
- 100ms high-speed sampling rate and  $\pm 0.5\%$  display accuracy
- Switch between relay output and SSR drive output (patent) \*
- SSR drive output (SSRP function) control options: ON/OFF control, cycle control, phase control
- Compact design with large display panels for easier reading
- Connector plug types offer easier wiring and maintenance (TCN4S- -P)

\*Korea Patent Registration 10-1002582, U.S.A. Patent Registration 8645000, Japan Patent Registration 3184816, China Patent Registration ZL200980111733.X, Vietnam Patent Registration 1-0012131, India Patent Registration 291573, Indonesia Patent Registration IDP003216

### Safety Considerations

- Observe all 'Safety Considerations' for safe and proper operation to avoid hazards.
- **⚠** symbol indicates caution due to special circumstances in which hazards may occur.

**⚠ Warning** Failure to follow instructions may result in serious injury or death

- 01. Fail-safe device must be installed when using the unit with machinery that may cause serious injury or substantial economic loss.** (e.g. nuclear power control, medical equipment, ships, vehicles, railways, aircraft, combustion apparatus, safety equipment, crime/disaster prevention devices, etc.)  
Failure to follow this instruction may result in personal injury, economic loss or fire.
- 02. Do not use the unit in the place where flammable/explosive/corrosive gas, high humidity, direct sunlight, radiant heat, vibration, impact or salinity may be present.**  
Failure to follow this instruction may result in explosion or fire.
- 03. Install on a device panel to use.**  
Failure to follow this instruction may result in fire or electric shock.
- 04. Do not connect, repair, or inspect the unit while connected to a power source.**  
Failure to follow this instruction may result in fire or electric shock.
- 05. Check 'Connections' before wiring.**  
Failure to follow this instruction may result in fire.
- 06. Do not disassemble or modify the unit.**  
Failure to follow this instruction may result in fire or electric shock.

**⚠ Caution** Failure to follow instructions may result in injury or product damage

- 01. When connecting the power input and relay output, use AWG 20 (0.50 mm<sup>2</sup>) cable or over and tighten the terminal screw with a tightening torque of 0.74 to 0.90 N m.**  
**When connecting the sensor input and communication cable without dedicated cable, use AWG 28 to 16 cable and tighten the terminal screw with a tightening torque of 0.74 to 0.90 N m.**  
Failure to follow this instruction may result in fire or malfunction due to contact failure.
- 02. Use the unit within the rated specifications.**  
Failure to follow this instruction may result in fire or product damage
- 03. Use a dry cloth to clean the unit, and do not use water or organic solvent.**  
Failure to follow this instruction may result in fire or electric shock.
- 04. Keep the product away from metal chip, dust, and wire residue which flow into the unit.**  
Failure to follow this instruction may result in fire or product damage.

## Cautions during Use

- Follow instructions in 'Cautions during Use'. Otherwise, it may cause unexpected accidents.
- Check the polarity of the terminals before wiring the temperature sensor. For RTD temperature sensor, wire it as 3-wire type, using cables in same thickness and length. For thermocouple (TC) temperature sensor, use the designated compensation wire for extending wire.
- Keep away from high voltage lines or power lines to prevent inductive noise. In case installing power line and input signal line closely, use line filter or varistor at power line and shielded wire at input signal line. Do not use near the equipment which generates strong magnetic force or high frequency noise.
- Install a power switch or circuit breaker in the easily accessible place for supplying or disconnecting the power.
- Do not use the unit for other purpose (e.g. voltmeter, ammeter), but temperature controller.
- When changing the input sensor, turn off the power first before changing. After changing the input sensor, modify the value of the corresponding parameter.
- 24 VAC~, 24-48 VDC≐ power supply should be insulated and limited voltage/current or Class 2, SELV power supply device.
- Make a required space around the unit for radiation of heat. For accurate temperature measurement, warm up the unit over 20 min after turning on the power.
- Make sure that power supply voltage reaches to the rated voltage within 2 sec after supplying power.
- Do not wire to terminals which are not used.
- This unit may be used in the following environments.
  - Indoors (in the environment condition rated in 'Specifications')
  - Altitude Max. 2,000 m
  - Pollution degree 2
  - Installation category II

## Ordering Information

This is only for reference, the actual product does not support all combinations. For selecting the specified model, follow the Autonics website .

**T C 4 ① - ② ③ ④**

### ① Size

S: DIN W 48 × H 48 mm  
 SP: DIN W 48 × H 48 mm (11 pin plug type)  
 Y: DIN W 72 × H 36 mm  
 M: DIN W 72 × H 72 mm  
 H: DIN W 48 × H 96 mm  
 W: DIN W 96 × H 48 mm  
 L: DIN W 96 × H 96 mm

### ③ Power supply

2: 24 VAC~ 50/60 Hz, 24-48 VDC≐  
 4: 100-240 VAC~ 50/60 Hz

### ④ Control output

N: Indicator - without control output  
 R: Relay + SSR drive

### ② Alarm output

N: No alarm  
 1: 1 alarm  
 2: 2 alarm

## Product Components

- Product
- Instruction manual
- Bracket

## Sold Separately

- 11 pin socket: PG-11, PS-11 (N)
- Terminal protection cover: RSA / RMA / RHA / RLA Cover

## Specifications

Series	TC4□-□2□	TC4□-□4□
<b>Power supply</b>	24 VAC~ 50/60 Hz ±10% 24-48 VDC≐ ±10%	100 - 240 VAC~ 50/60 Hz ±10%
<b>Power consumption</b>	AC: ≤ 5 VA, DC: ≤ 3 W	≤ 5 VA
<b>Sampling period</b>	100 ms	
<b>Input specification</b>	Refer to 'Input Type and Using Range.'	
<b>Control output</b>	Relay	250 VAC~ 3 A, 30 VDC≐ 3 A, 1a
	SSR	12 VDC≐ ±2 V, ≤ 20 mA
<b>Alarm output</b>	250 VAC~ 1 A 1a	
<b>Display type</b>	7 Segment (red, green, yellow), LED type	
<b>Control type</b>	Heating, Cooling	ON/OFF, P, PI, PD, PID Control
<b>Hysteresis</b>	1 to 100 (0.1 to 50.0) °C/°F	
<b>Proportional band (P)</b>	0.1 to 999.9 °C/°F	
<b>Integral time (I)</b>	0 to 9,999 sec	
<b>Derivative time (D)</b>	0 to 9,999 sec	
<b>Control cycle (T)</b>	0.5 to 120.0 sec	
<b>Manual reset</b>	0.0 to 100.0%	
<b>Relay life cycle</b>	Mechanical	OUT1/2, AL1/2: ≥ 5,000,000 operations
	Electrical	OUT1/2: ≥ 200,000 operations (load resistance: 250 VAC~ 3A) AL1/2: ≥ 300,000 operations (load resistance: 250 VAC~ 1 A)
<b>Dielectric strength</b>	Between input terminal and power terminal: 1,000 VAC~ 50/60 Hz for 1 min	Between input terminal and power terminal: 2,000 VAC~ 50/60 Hz 1 min
<b>Vibration</b>	0.75 mm amplitude at frequency 5 to 55Hz (for 1 min) in each X, Y, Z direction for 2 hours	
<b>Insulation resistance</b>	≥ 100 MΩ (500 VDC≐ megger)	
<b>Noise immunity</b>	Square shaped noise (pulse width: 1 μs) by noise simulator ±2 kV R-phase, S-phase	
<b>Memory retention</b>	≈ 10 years (non-volatile semiconductor memory type)	
<b>Ambient temperature</b>	-10 to 50 °C, storage: -20 to 60 °C (no freezing or condensation)	
<b>Ambient humidity</b>	35 to 85%RH, storage: 35 to 85%RH (no freezing or condensation)	
<b>Insulation type</b>	Mark: □, double or reinforced insulation (dielectric strength between the measuring input part and the power part: 1 kV)	Mark: □, double or reinforced insulation (dielectric strength between the measuring input part and the power part: 2 kV)
<b>Approval</b>	CE, RoHS, ENEC	
<b>Unit weight (packaged)</b>	• TC4S: ≈ 94 g (≈ 141 g)	• TC4SP: ≈ 76 g (≈ 123 g)
	• TC4Y: ≈ 85 g (≈ 174 g)	• TC4M: ≈ 133 g (≈ 204 g)
	• TC4W: ≈ 122 g (≈ 194 g)	• TC4H: ≈ 122 g (≈ 194 g)
	• TC4L: ≈ 155 g (≈ 254 g)	

## Input Type and Using Range

The setting range of some parameters is limited when using the decimal point display.

Input type		Decimal point	Display	Using range (°C)	Using range (°F)
Thermo-couple	K (CA)	1	ℓℓℓℓ	-50 to 1,200	-58 to 2,192
	J (IC)	1	ℓℓℓℓ	-30 to 500	-22 to 932
	L (IC)	1	ℓℓℓℓ	-40 to 800	-40 to 1,472
RTD	Cu50 Ω	1	ℓℓℓℓ	-50 to 200	-58 to 392
		0.1	ℓℓℓℓ	-50.0 to 200.0	-58.0 to 392.0
	DPt100 Ω	1	dℓℓℓℓ	-100 to 400	-148 to 752
		0.1	dℓℓℓℓ	-100.0 to 400.0	-148.0 to 752.0

## Display accuracy

Input type	Using temperature	Display accuracy
Thermo-couple RTD	At room temperature (23°C ±5°C)	(PV ±0.5% or ±1°C higher one) ±1-digit • Thermocouple L, RTD Cu50 Ω: (PV ±0.5% or ±2°C higher one) ±1-digit
	Out of room temperature range	(PV ±0.5% or ±2°C higher one) ±1-digit • Thermocouple L, RTD Cu50 Ω: (PV ±0.5% or ±3°C higher one) ±1-digit

- In case of TC4SP Series, ±1°C will be added.
- If the input specification is set to 'decimal point 0.1' display, add ±1°C by accuracy standard.

## Unit Descriptions

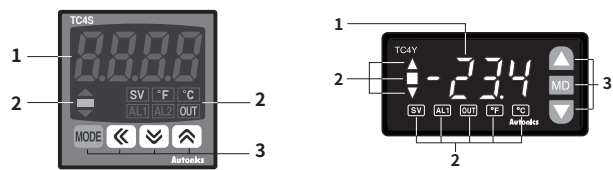

### 1. Temperature Display part (Red)

- Run mode: Displays PV (Present value).
- Setting mode: Displays parameter name, setting value.

### 3. Input key

Display	Name
[MODE]	Mode key
[<], [v], [▲]	Setting value control key

### 2. Indicator

Display	Name	Description
▲ ■ ▼	Deviation	Displays PV deviation based on SV (Setting value) by LED. ▲: ON when deviation is over +2°C ■: ON when deviation is within ±2°C ▼: ON when deviation is under -2°C Flashes during auto tuning every 1 sec
SV	Setting value	Turns ON when SV is displayed on temperature display part.
°C, °F	Temperature unit	Displays selected unit (parameter).
AL1/2	Alarm output	Turns ON when each alarm output is ON.
OUT	Control output	Turns ON when control output is ON. • CYCLE/PHASE control of SSR drive output: Turns ON when MV is over 3.0%. (only for AC power model)

## Errors

Display	Description	Troubleshooting
oPE n	Flashes when input sensor is disconnected or sensor is not connected.	Check input sensor status.
HHHH	Flashes when PV is higher than input range.	When input is within the rated input range, this display disappears.
LLLL	Flashes when PV is lower than input range.	

## Dimensions

- Unit: mm, For the detailed drawings, follow the Autonics website.
- Below is based on TC4S Series.

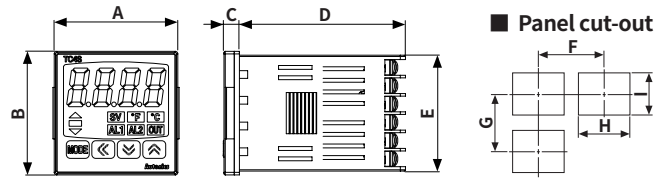

Series	Body					Panel cut-out			
	A	B	C	D	E	F	G	H	I
TC4S	48	48	6	64.5	45	≥ 65	≥ 65	45 <sup>+0.6</sup> <sub>0</sub>	45 <sup>+0.6</sup> <sub>0</sub>
TC4SP	48	48	6	72.2	45	≥ 65	≥ 65	45 <sup>+0.6</sup> <sub>0</sub>	45 <sup>+0.6</sup> <sub>0</sub>
TC4Y	72	36	7	77	30	≥ 91	≥ 40	68 <sup>+0.7</sup> <sub>0</sub>	31.5 <sup>+0.5</sup> <sub>0</sub>
TC4W	96	48	6	64.5	44.7	≥ 115	≥ 65	92 <sup>+0.8</sup> <sub>0</sub>	45 <sup>+0.6</sup> <sub>0</sub>
TC4M	72	72	6	64.5	67.5	≥ 90	≥ 90	68 <sup>+0.7</sup> <sub>0</sub>	68 <sup>+0.7</sup> <sub>0</sub>
TC4H	48	96	6	64.5	91.5	≥ 65	≥ 115	45 <sup>+0.6</sup> <sub>0</sub>	92 <sup>+0.8</sup> <sub>0</sub>
TC4L	96	96	6	64.5	91.5	≥ 115	≥ 115	92 <sup>+0.8</sup> <sub>0</sub>	92 <sup>+0.8</sup> <sub>0</sub>

## Bracket

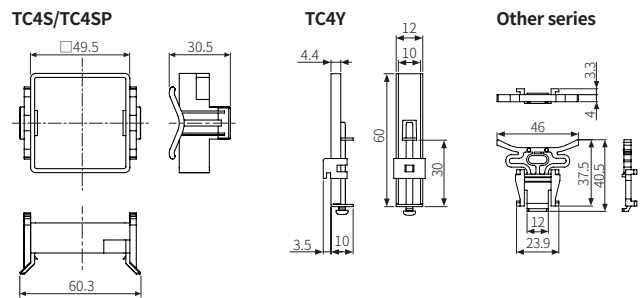

## Installation Method

### TC4S

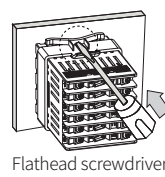

Flathead screwdriver

### TC4Y

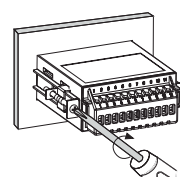

Crosshead screwdriver

### Other series

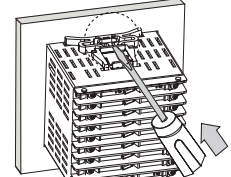

Flathead screwdriver

Mount the product to panel with bracket, push it to arrow direction by using screw driver.

- In case of TC4Y Series, fasten the bolts.

## Crimp Terminal Specifications

- Unit: mm, Use the crimp terminal of follow shape.

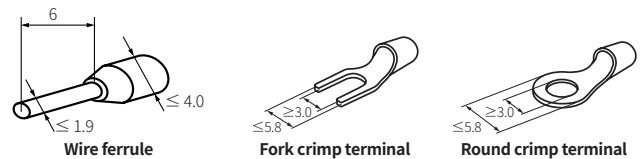

## Connections

### TC4S

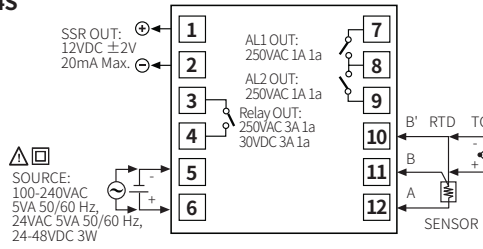

### TC4SP

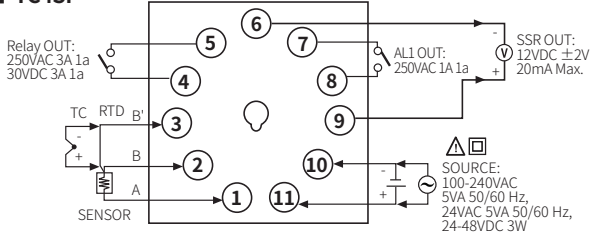

### TC4Y

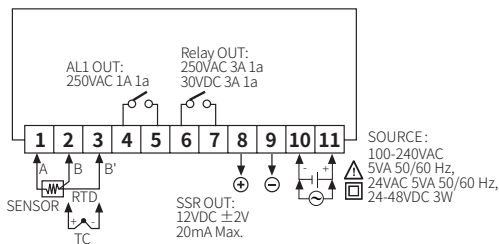

### TC4W

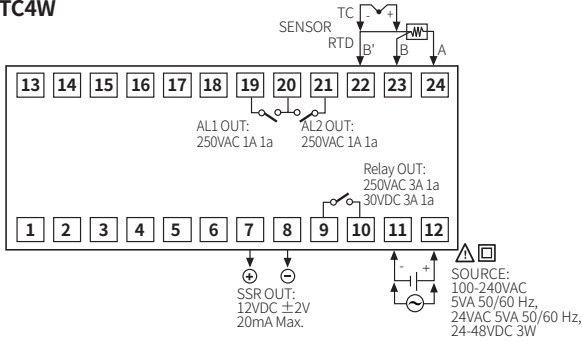

### TC4M

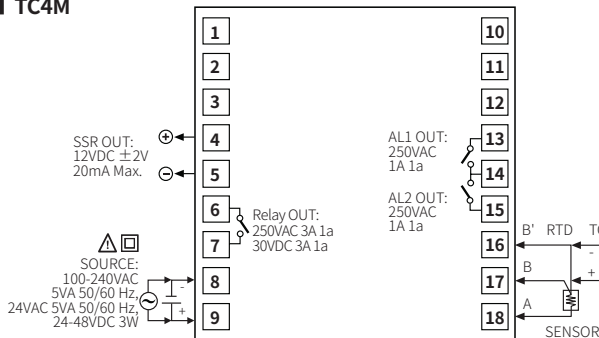

### TC4H/L

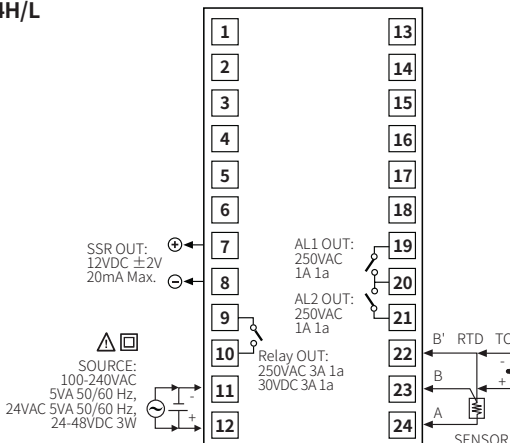

## Mode Setting

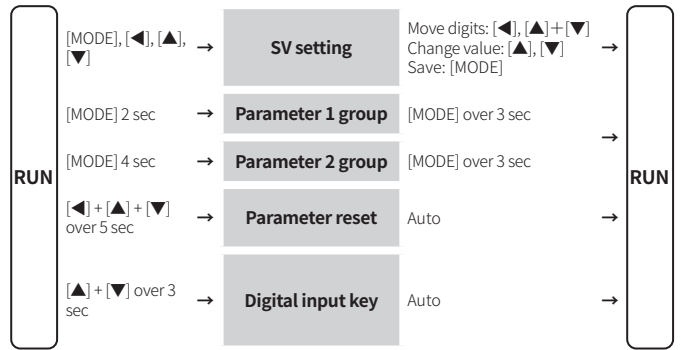

## Parameter Setting

- Some parameters are activated/deactivated depending on the model or setting of other parameters. Refer to the description of each item.
- The setting range in parentheses is for using the decimal point display in the input specification.
- If there is no key input for more than 30 seconds in each parameter, it returns to RUN mode.
- When pressing the [MODE] key within 1 second after returning to the operation mode from the parameter group, it will enter the parameter group before returning.
- [MODE] key: Saves the current parameter setting value and moves to the next parameter.
  - [◀] key: Moves the column when changing the set value
  - [▲], [▼] keys: Selects the parameter / Changes the set value
- Recommended parameter setting sequence: Parameter 2 group → Parameter 1 group → SV setting mode

### Parameter 1 group

- Only appears at control output model.

Parameter	Display	Default	Setting range	Condition
1-1 AL1 alarm temperature	AL1	125.0	Deviation alarm: -F.S. to F.S. °C/°F Absolute value alarm: Within input range	2-12/14 AL1/2 alarm operation: AM1 to AM6
1-2 AL2 alarm temperature	AL2	125.0	[2 alarm output model] Same as 1-1 AL1 alarm temperature	
1-3 Auto tuning	ALt	OFF	OFF: Stop, ON: Execution	
1-4 Proportional band	P	0.100	0.1 to 999.9 °C/°F	2-8 Control type: PID
1-5 Integral time	I	0.000	0 (OFF) to 9999 sec	
1-6 Derivative time	d	0.000	0 (OFF) to 9999 sec	
1-7 Manual reset	rESt	0.500	0.0 to 100.0%	2-8 Control type: PID & 1-5 Integral time: 0
1-8 Hysteresis	HYS	0.02	1 to 100 (0.1 to 50.0) °C/°F	2-8 Control type: ONOF

## Parameter 2 group

• In case of indicator model, only appears 2-1 to 4 / 2-19 parameters.

Parameter	Display	Default	Setting range	Condition
2-1 Input specification <sup>(01)</sup>	i n - t	ℰ ℰ ℰ	Refer to 'Input Type and Using Range'.	-
2-2 Temperature unit <sup>(01)</sup>	U n i t	°C	°C, °F	-
2-3 Input correction	i n - b	0000	-999 to 999 (-199.9 to 999.9) °C/°F	-
2-4 Input digital filter	ñ R u F	000.1	0.1 to 120.0 sec	-
2-5 SV low limit <sup>(02)</sup>	L - S u	- 050	Within 2-1 Input specification: Using range, L-SV ≤ H-SV - 1-digit °C/°F H-SV ≥ L-SV + 1-digit °C/°F	-
2-6 SV high limit <sup>(02)</sup>	H - S u	1200		-
2-7 Control output mode	o - F t	H E A T	HEAT: Heating, COOL: Cooling	-
2-8 Control type <sup>(03)</sup>	ℰ - ñ d	P i d	PID, ONOF: ON/OFF	-
2-9 Control output	o U t	r L Y	RLY: relay, SSR	-
2-10 SSR drive output type	55 r . ñ	5 t n d	[AC voltage model] STND: standard, CYCL: cycle, PHAS: phase	2-9 Control output: SSR
2-11 Control cycle	t	0200	0.5 to 120.0 sec	2-9 Control output: RLY 2-10 SSR drive output type: STND
		0020		2-9 Control output: SSR 2-10 SSR drive output type: STND
2-12 AL1 alarm operation <sup>(04)</sup>	AL - 1	AM Off AM1: Deviation high limit alarm AM2: Deviation low limit alarm AM3: Deviation high, low limit alarm AM4: Deviation high, low reverse alarm AM5: Absolute value high limit alarm AM6: Absolute value low limit alarm SBA: Sensor break alarm LBA: Loop break alarm (LBA)		-
2-13 AL1 alarm option		A: Standard alarm B: Alarm latch C: Standby sequence 1 D: Alarm latch and standby sequence 1 E: Standby sequence 2 F: Alarm latch and standby sequence 2 • Enter to option setting: Press [◀] key in 2-12 AL-1 alarm operation.		-
2-14 AL2 alarm operation <sup>(04)</sup>	AL - 2	AM2AL	[2 alarm output model] Same as 2-12/13 AL1 alarm operation/option	-
2-15 AL2 alarm option				-
2-16 Alarm output hysteresis	AMHS	0001	1 to 100 (0.1 to 50.0) °C/°F	2-12/14 AL1/2 alarm operation: AM1 to 6
2-17 LBA time	L b A t	0000	0 (OFF) to 9,999 sec or auto (auto tuning)	2-12/14 AL1/2 alarm operation: LBA
2-18 LBA band	L b A b	002	0 (OFF) to 999 (0.0 to 999.9) °C/°F or auto (auto tuning)	2-12/14 AL1/2 alarm operation: LBA & 2-17 LBA time: > 0
2-19 Digital input key	d i - t	5 t o P	STOP: Stop control output, AL.RE: Alarm reset, AT*: Auto tuning execution, OFF	*2-8 Control type: PID
2-20 Sensor error MV	E r . ñ u	0000	0.0: OFF, 100.0: ON	2-8 Control type: ONOF
			0.0 to 100.0%	2-8 Control type: PID
2-21 Lock	L o C	o F F	OFF LOC1: Parameter 2 group lock LOC2: Parameter 1/2 Group lock LOC3: Parameter 1/2 Group, SV setting lock	-
			[Indicator model] OFF LOC1: Parameter 2 group lock	-

01) Below parameters are initialized when the setting value is changed.

- Parameter 1 group: AL1/2 alarm temperature  
- Parameter 2 group: Input correction, SV high/low limit, Alarm output hysteresis, LBA time, LBA band  
- SV setting mode: SV

02) If SV is lower/higher than low/high limit when the value is changed, SV is changed to the low/high limit value.  
If 2-1 Input specification is changed, the value is changed to Min./Max. value of input specification.

03) When changing the value from PID to ONOF, each value of following parameter is changed.  
2-19 Digital input key: OFF, 2-20 Sensor error MV: 0.0 (When setting value is lower than 100.0)

04) 1-1/2 AL1, AL2 alarm temperature setting values are initialized when the setting value is changed.

## Function: Alarm

000.0

Alarm operation Alarm option

Set both alarm operation and alarm option by combining. Each alarm operates individually in two alarm output models. When the current temperature is out of alarm range, alarm clears automatically.

## Operation

• H: Alarm output hysteresis

Name	Alarm operation	Description
-	-	No alarm output
Deviation high limit		If deviation between PV and SV as high-limit is higher than set value of deviation temperature, the alarm output will be ON.
	High deviation: Set as 10°C	
Deviation low limit		If deviation between PV and SV as low limit is higher than set value of deviation temperature, the alarm output will be ON.
	Low deviation: Set as 10°C	
Deviation high, low limit		If deviation between PV and SV as high/low-limit is higher than set value of deviation temperature, the alarm output will be ON.
	High, Low deviation: Set as 10°C	
Deviation high, low limit reverse		If deviation between PV and SV as high/low-limit is lower than set value of deviation temperature, the alarm output will be OFF.
	High, Low deviation: Set as 10°C	
Absolute value high limit		If PV is higher than the absolute value, the output will be ON.
	Absolute value: Set as 90°C	
Absolute value low limit		If PV is lower than the absolute value, the output will be ON.
	Absolute value: Set as 110°C	
Sensor break	-	It will be ON when it detects sensor disconnection.
Loop break	-	It will be ON when it detects loop disconnection.

## Option

Name	Description	Condition of re-apply
Standard alarm	If it is an alarm condition, alarm output is ON. If it is a clear alarm condition, alarm output is OFF.	-
Alarm latch	If it is an alarm condition, alarm output is ON and maintains ON status.	-
Standby sequence 1	First alarm condition is ignored and from second alarm condition, standard alarm operates. When power is supplied and it is an alarm condition, this first alarm condition is ignored and from the second alarm condition, standard alarm operates.	Power ON
Alarm latch and standby sequence 1	If it is an alarm condition, it operates both alarm latch and standby sequence. When power is supplied and it is an alarm condition, this first alarm condition is ignored and from the second 1 alarm condition, alarm latch operates.	
Standby sequence 2	First alarm condition is ignored and from second alarm condition, standard alarm operates. When re-applied standby sequence and if it is alarm condition, alarm output does not turn ON. After clearing alarm condition, standard alarm operates.	Power ON, change SV, change alarm temperature / operation or change STOP to RUN mode
Alarm latch and standby sequence 2	Basic operation is same as alarm latch and standby sequence 1. It operates not only by power ON/OFF, but also alarm set value, or alarm option changing. When re-applied standby sequence and if it is alarm condition, alarm output does not turn ON. After clearing alarm condition, alarm latch operates.	

## Segment Table

The segments displayed on the product indicate the following meanings. It may differ depending on the product.

7 segment				11 segment				12 segment				16 segment			
0	0	1	1	0	0	1	1	0	0	1	1	0	0	1	1
1	1	2	2	1	1	2	2	1	1	2	2	1	1	2	2
2	2	3	3	2	2	3	3	2	2	3	3	2	2	3	3
3	3	4	4	3	3	4	4	3	3	4	4	3	3	4	4
4	4	5	5	4	4	5	5	4	4	5	5	4	4	5	5
5	5	6	6	5	5	6	6	5	5	6	6	5	5	6	6
6	6	7	7	6	6	7	7	6	6	7	7	6	6	7	7
7	7	8	8	7	7	8	8	7	7	8	8	7	7	8	8
8	8	9	9	8	8	9	9	8	8	9	9	8	8	9	9
9	9	A	A	9	9	A	A	9	9	A	A	9	9	A	A
A	A	B	B	A	A	B	B	A	A	B	B	A	A	B	B
B	B	C	C	B	B	C	C	B	B	C	C	B	B	C	C
C	C	D	D	C	C	D	D	C	C	D	D	C	C	D	D
D	D	E	E	D	D	E	E	D	D	E	E	D	D	E	E
E	E	F	F	E	E	F	F	E	E	F	F	E	E	F	F
F	F	G	G	F	F	G	G	F	F	G	G	F	F	G	G
G	G	H	H	G	G	H	H	G	G	H	H	G	G	H	H
H	H	I	I	H	H	I	I	H	H	I	I	H	H	I	I