

Ø 22/25 mm Pilot Lights



L2RR Series CATALOG

For your safety, read and follow the considerations written in the instruction manual, other manuals and Autonics website.

The specifications, dimensions, etc. are subject to change without notice for product improvement. Some Models may be discontinued without notice.

Features

- High luminance LED
- Available in various colors
- Long-lasting durability

Safety Considerations

- Observe all 'Safety Considerations' for safe and proper operation to avoid hazards.
- ⚠ symbol indicates caution due to special circumstances in which hazards may occur.

⚠ Warning Failure to follow instructions may result in serious injury or death.

- 01. Fail-safe device must be installed when using the unit with machinery that may cause serious injury or substantial economic loss. (e.g. nuclear power control, medical equipment, ships, vehicles, railways, aircraft, combustion apparatus, safety equipment, crime / disaster prevention devices, etc.)**
Failure to follow this instruction may result in personal injury, economic loss or fire.
- 02. Do not use the unit in the place where flammable / explosive / corrosive gas, high humidity, direct sunlight, radiant heat, vibration, impact, or salinity may be present.**
Failure to follow this instruction may result in explosion or fire.
- 03. Install on a device panel to use.**
Failure to follow this instruction may result in fire or electric shock.
- 04. Do not connect, repair, or inspect the unit while connected to a power source.**
Failure to follow this instruction may result in fire or electric shock.
- 05. Do not disassemble or modify the unit.**
Failure to follow this instruction may result in fire or electric shock.

⚠ Caution Failure to follow instructions may result in injury or product damage.

- 01. This unit shall not be used outdoors.**
Failure to follow this instruction may result in shortening the life cycle of the product or electric shock.
- 02. Use the unit within the rated specifications.**
Failure to follow this instruction may result in fire or product damage.
- 03. Do not use the load beyond rated switching capacity contact.**
Failure to follow this instruction may result in fire, relay broken, contact melt, insulation failure or contact failure.
- 04. For wiring the product, do not pull the wiring excessively or apply excessive force.**
Failure to follow this instruction may result in product damage or malfunction.
- 05. Use dry cloth to clean the unit, and do not use water or organic solvent.**
Failure to follow this instruction may result in fire or electric shock.
- 06. Keep the product away from metal chip, dust, and wire residue which from flowing into the unit.**
Failure to follow this instruction may result in fire or product damage.

Specifications

Series	L2RR Series
Installation	Extended
Shock	300 m/s ² (≈ 30 G) in each X, Y, Z direction for 3 times
Shock (malfunction)	100 m/s ² (≈ 10 G) in each X, Y, Z direction for 3 times
Vibration	1.5 mm amplitude at frequency of 10 to 55 Hz (for 1 min) in each X, Y, Z direction for 2 hours
Vibration (malfunction)	1.5 mm amplitude at frequency of 10 to 55 Hz (for 1 min) in each X, Y, Z direction for 10 minutes
Ambient temperature	-15 to 55 °C, storage: -25 to 65 °C (no freezing or condensation)
Ambient humidity	35 to 85 %RH, storage: 35 to 85 %RH (no freezing or condensation)
Protection structure	Light unit: IP52 (IEC standard)
Approval	CE 
Light unit weight	≈ 15.5 g
Housing weight	≈ 7 g

LED blocks

Rated voltage	AC/DC voltage type: 12-24 VAC~ 50/60 Hz, 12-24 VDC== AC voltage type: 110-220 VAC~ 50/60 Hz
Current consumption	≤ 20 mA
Approval	CE 
Weight	AC/DC voltage type: ≈ 11 g, AC voltage type: ≈ 12 g

Sold Separately

- LED blocks (SA□-L□□□)
- Locking handle (SA□-LH)
- Switch washer (SA-SW□)

Assembly / Disassembly

- Assembly order: ①→②→③→④
- Disassembly order: a→b→c→d

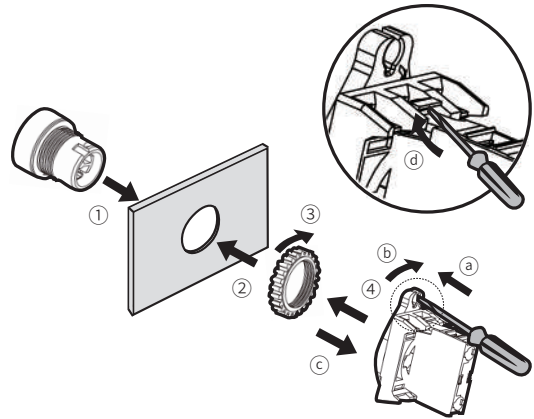

Control Switches	Panel thickness	Tightening torque
Ø 22/25/30 mm	Max. 6 mm	≤ 1.47 N·m

Ordering Information

This is only for reference. For selecting the specified Model, follow the Autonics website.

Model is based on light unit+block combination. Light units or blocks are sold separately. In case of block, refer to control switch accessories.

L2RR	①	-	L	②	③	④	⑤
Light unit						Block	

① Letter marking (flat round /square) ④ LED block

No mark: Lamp (light unit + singular type block) D: 1 AC/DC voltage type
L: 1 AC voltage type

No mark: None (light unit + modular type block)

U: None (light unit) ⁰¹⁾

② Head type

- 1: Extended dome
- 2: Extended horn
- 3: Extended flat round
- 4: Extended flat square

⑤ Block

- No mark: Singular type
- M: Modular type

③ Head color

- R: Red
- B: Blue
- G: Green
- Y: Yellow
- W: White

01) Only available for light unit. Select the block separately.

Model	Contact block		LED block	
	A contact	B contact	AC/DC voltage	AC voltage
L2RR-L1□D(M)			1	-
L2RR-L1□L(M)			-	1
L2RR-L2□D(M)			1	-
L2RR-L2□L(M)			-	1
L2RR-L3□D(M)	-	-	1	-
L2RR-L3□L(M)			-	1
L2RR-L4□D(M)			1	-
L2RR-L4□L(M)			-	1

Dimensions

- Unit: mm, For the detailed drawings, follow the Autonics website.
- Panel thickness: ≤ 6 mm

■ L2RR-L1 □ (extended dome head, singular type block)

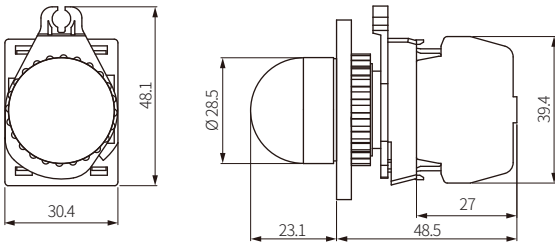

■ L2RR-L1 □ M (extended dome head, modular type block)

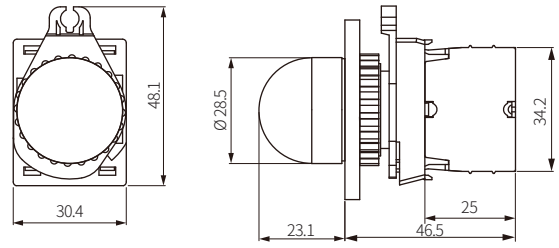

■ L2RR-L2 □ (extended horn head, singular type block)

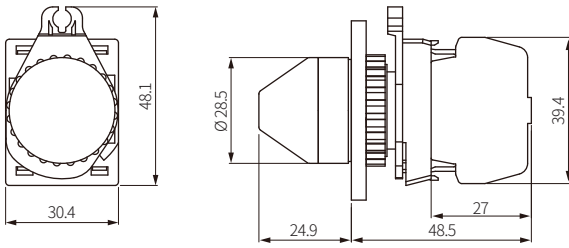

■ L2RR-L2 □ M (extended horn head, modular type block)

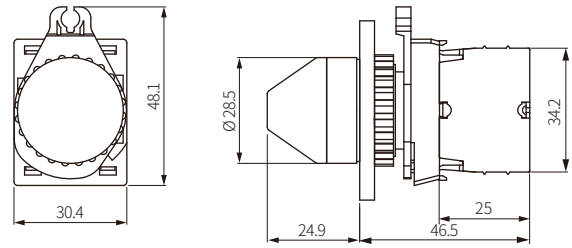

■ L2RR-L3 □ (extended flat round head, singular type block)

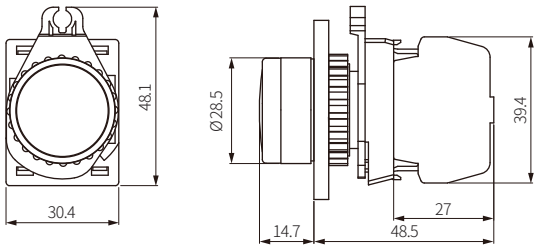

■ L2RR-L3 □ M (extended flat round head, modular type block)

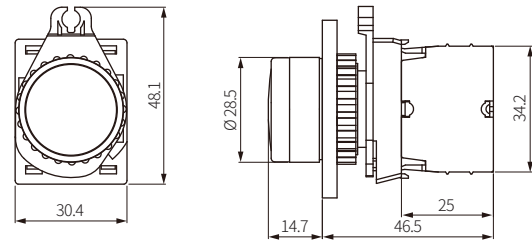

■ L2RR-L4 □ (extended flat square head, singular type block)

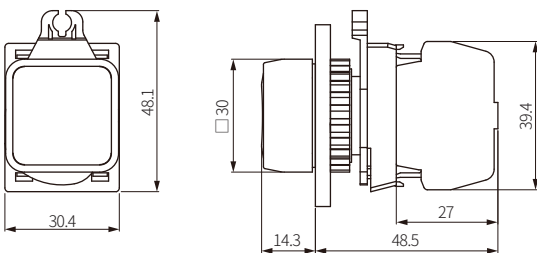

■ L2RR-L4 □ M (extended flat square head, modular type block)

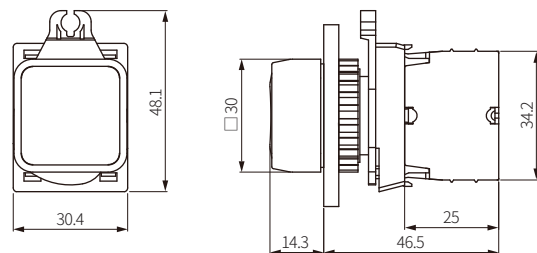

■ Panel cut-out

