

2D 4-Channel Laser Scanners



LSE3 Series PRODUCT MANUAL

For your safety, read and follow the considerations written in the instruction manual, other manuals and Autonics website.

The specifications, dimensions, etc. are subject to change without notice for product improvement. Some models may be discontinued without notice.

Features

- 90° detection angle, up to 10 × 10 m detection area
- Supports up to 4-channels
- Aluminum die-cast housing minimizes interference from 5G communication repeaters
- Various filter functions to prevent malfunction due to fog, rain, snow and dust
- Operation indicator to identify operation status and errors
: check status even in unstable conditions or change in installation location
- Ethernet communication supported
- Dedicated software atLiDAR provided
: PC, Mobile (Android)

Safety Considerations

- Observe all 'Safety Considerations' for safe and proper operation to avoid hazards.
- ⚠ symbol indicates caution due to special circumstances in which hazards may occur.

⚠ Warning Failure to follow instructions may result in serious injury or death.

- 01. Fail-safe device must be installed when using the unit with machinery that may cause serious injury or substantial economic loss. (e.g. nuclear power control, medical equipment, ships, vehicles, railways, aircraft, combustion apparatus, safety equipment, crime / disaster prevention devices, etc.)**
Failure to follow this instruction may result in economic loss, personal injury or fire.
- 02. Do not use the unit in the place where flammable / explosive / corrosive gas, high humidity, direct sunlight, radiant heat, vibration, impact, or salinity may be present.**
Failure to follow this instruction may result in fire or explosion.
- 03. This product is not safety sensor and does not observe any domestic nor international safety standard.**
Do not use this product with the purpose of injury prevention or life protection, as well as in the place where economic loss may be expected.
- 04. Do not connect, repair, or inspect the unit while connected to a power source.**
Failure to follow this instruction may result in fire.
- 05. Check connections and connect cables.**
Failure to follow this instruction may result in fire.
- 06. Do not disassemble or modify the unit.**
Failure to follow this instruction may result in fire.

⚠ Caution Failure to follow instructions may result in injury or product damage.

- 01. Do not stare at the laser emitter.**
Failure to follow this instruction may result in eye damage.
- 02. Use the unit within the rated specifications.**
Failure to follow this instruction may result in fire or product damage.
- 03. Use dry cloth to clean the unit. Do not use water or organic solvent when cleaning the unit.**
Failure to follow this instruction may result in fire.
- 04. Do not apply high pressure to the laser scanner to clean it.**

Cautions during Use

- Follow instructions in 'Cautions during Use'. Otherwise, it may cause unexpected accidents.
- Power supply should be insulated and limited voltage / current or Class 2, SELV power supply device.
- After supplying power, the sensor performs self-check for about 30 sec. When self-checking, error occurrence, and teaching, the laser scanner outputs the same as it sensed obstacle.
- Do not arbitrarily extend the length of the laser scanner power I/O cable and communication cable. It may cause malfunction.
- Mutual optical interference between laser scanners and photoelectric sensors may result in malfunction.
- Mutual optical interference between laser scanners may result in malfunction.
- Do not touch or contaminate the laser scanner front cover. It may cause malfunction.
- Objects cannot be scanned when covering the front cover of the laser scanner.
- When the laser scanner is moved to another position, use it after re-teaching.
- Do not drop the unit. It may cause malfunction.
- Installing the laser scanner in the place where smoke, fog, dust, or corrosion is heavy may result in malfunction.
- When installing the laser scanner outdoors, take protective measures. Otherwise, it may result in product damage.
- Keep away from high voltage lines or power lines to prevent inductive noise. In case of installing power line and input signal line closely, use line filter or varistor at power line and shield wire at input signal line.

- Do not use the laser scanner near the equipment which generates strong magnetic force or high frequency noise.
- Cover with shields, hoods, or etc. to prevent direct incidence of strong light (direct rays of sunlight, incandescent) into the laser scanner beam spread angle.
- Fix the laser scanner in position with the bracket. Vibration may result in malfunction.
- When IP address of the laser scanner and wireless router is same, the communication does not connected. Set the wireless network (Wifi) to "Disable" in the network settings of the Windows operating system.
- This unit may be used in the following environments.
 - Indoors / Outdoors (in the environment condition rated in 'Specifications')
 - Altitude max. 2,000 m
 - Pollution degree 2
 - Installation category II

Ordering Information

This is only for reference, the actual product does not support all combinations. For selecting the specified model, follow the Autonics website.

LSE3 - ① ② ③ ④ - ⑤

① Scanning channels

4: 4 CH

② Scan angle

A: 90°

③ Detection distance

Number: Detection distance (unit: m)

④ Control output

R2: 2 Relay output

⑤ Ethernet TCP/IP

ET: Supported

Product Components

- Product
- Instruction manual

Sold Separately

- Main bracket: BK-LSE3
- Sub bracket: BK-LSE2-SUB

Software

Download the installation file and the manuals from the Autonics website. Supported devices are different for each software version.

■ atLiDAR (PC, V2.3 or later)

atLiDAR is the management program for laser scanner parameter settings, status information and monitoring data, etc.

This program communicates with the laser scanner via Ethernet communication.

■ atLiDAR (mobile)

atLiDAR is Android only mobile application that can manage monitoring data such as laser scanner parameter settings and status information.

Connect the laser scanner with atLiDAR by connecting the USB3.0-C to Ethernet adapter.

Installation Order

For details of atLiDAR (PC / mobile) settings, refer to the software manual.

01. Install the laser scanner.

Secure the laser scanner to the installation location.

02. Install the laser scanner program to PC.

Download the software provided by Autonics website.

03. Connect the laser scanner and the PC, and set the network.

Refer to the Network Setting.

04. Laser scanner function setting

Use atLiDAR (PC / mobile), set each function to adequate the installation environment of the laser scanner and the obstacles to be detected.

Mounting Bracket

- Connect the sensor and the main bracket using 4 M4 × L8 bolts.
 - Adjust the beam position using 3 M5 bolts that are fastened to the main bracket.
 - After adjusting the beam position, use 2 M4 × L10 bolts to fix the main bracket so that it does not shake.
- The additional sub bracket combinations are available for installation environment.
 - For details, refer to the product manual.

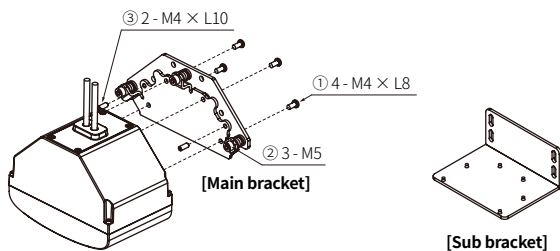

Network Setting

- Configure the network settings of LiDAR sensor via atLiDAR (PC).
- For initial IP address, refer to the table as below.

IP address	192.168.0.1
Subnet mask	255.255.255.0
Gateway	192.168.0.2

Cautions for Installation

■ Mutual interference

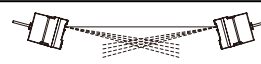

Tilt the devices and install them so that the scanning planes are tilted to each other.

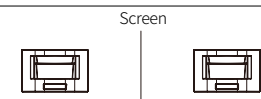

Install a screen to block direct laser beam interference between the devices.

■ Radiation guide



Detection width may vary depending on the laser aperture angle (0 to 90°). Refer to the radiation sticker attached to the front of the product for installation.

Connections

■ Power I / O cable

Color	Pin	Signal	Function
Brown	1	+V	+V
Blue	2	GND	GND
Yellow	3	OUT1_A	Obstacle detection output
Green	4	OUT1_B	
Red	5	OUT2_A	Error status output
Gray	6	OUT2_B	
White	7	IN_A	Output test mode
Black	8	IN_B	

■ Ethernet cable

Color	Pin	Signal
White	1	TX+
Black	2	TX-
Red	3	RX+
-	4	-
-	5	-
Green	6	RX-
-	7	-
-	8	-

- The input / output signals can operate in both direction regardless of the polarity.
- When the output test mode is not used, do not wire both end of input terminals (open), or connect with no. 2 terminal (blue, GND).

Control Input / Output Status

Output Input	OUT1 (obstacle detection output)	OUT2 (error status output)
ON	ON - • Obstacle detection • Teaching	ON -
OFF	ON • Error status • Scanning ready (approx. 30 sec after power on)	ON • Error status • Scanning ready (approx. 30 sec after power on)
	OFF • Obstacle non-detection	OFF • Normal status

Circuit

■ Photocoupler input

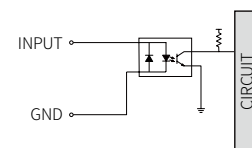

■ PhotoMOS relay output

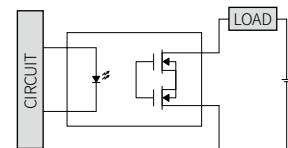

Dimensions

- Unit: mm, For the detailed drawings, follow the Autonics website.

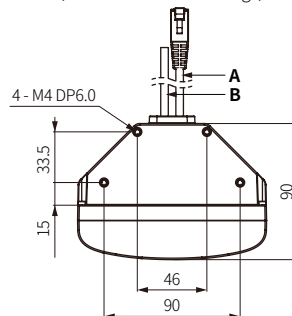

A	Ethernet cable
B	Power I / O cable
C	Window of laser for detection
D	Indicators (1, 2), laser for installation

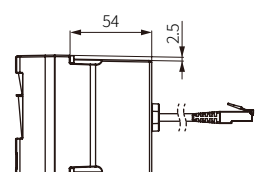
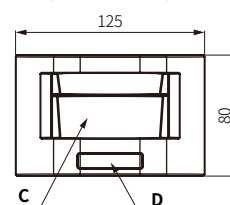

Specifications

Model	LSE3-4A5R2-ET	LSE3-4A10R2-ET
Laser for detection emitting property	Infrared laser: 1	
Laser class	CLASS 1	
Wave length band	905 nm	
Max. pulse output power	80 W	
Laser for installation emitting property	Visible light laser: 3	
Laser class	CLASS 3R	
Wave length band	650 nm	
Max. CW output power	4 mW	
Min. object size⁽⁰¹⁾	Detection distance of 3 m : 2.1 × 2.1 × 2.1 cm Detection distance of 5 m : 3.5 × 3.5 × 3.5 cm	Detection distance of 3 m : 2.1 × 2.1 × 2.1 cm Detection distance of 5 m : 3.5 × 3.5 × 3.5 cm Detection distance of 10 m : 7.0 × 7.0 × 7.0 cm
Scanning frequency	15 Hz	
Response time	≤ 20 to 80 ms + monitoring time	
Scanning mode	Motion and presence	
Monitoring zone⁽⁰²⁾	0.3 × 0.3 to 5.6 × 5.6 m	0.3 × 0.3 to 10 × 10 m
Front contamination⁽⁰³⁾	Normal operation with max. 30 % contamination of one material	
Angular resolution	0.4 °	
Aperture angle	90 °	
Object reflectivity⁽⁰⁴⁾	≥ 2 %	
Certification	CE	
Korean Railway Standards	KRS SG 0068	
Unit weight (package)	≈ 0.9 kg (≈ 1.1 kg)	

01) At object reflectivity: 90 % (Kodak Gray card R-27, White), min. object size: OFF

02) At object reflectivity: 10 %, fog filter level: 0, based on the concentrated monitoring zone 0.3 m setting

03) At object reflectivity: 90 %, fog filter level: 0

04) At detection distance: 2.5 m, fog filter level: 0, object size = W 700 × H 300 × L 200 mm

Power supply	10 to 35 VDC≒
Power consumption	≤ 10 W
Input	Photocoupler input: 1 H ⁽⁰¹⁾ : ≥ 8 - 30 VDC≒, L: ≤ 3 VDC≒
Output	PhotoMOS relay output: 2 Resistive load: 35 VDC≒ / 24 VAC~, ≤ 80 mA
Vibration	2 G (RMS 18.7 m/s ²)
Shock	30 G / 18 ms
Ambient illuminance	≤ 100,000 lx
Ambient temperature	-30 to 60 °C, storage: -30 to 70 °C (no freezing or condensation)
Ambient humidity	0 to 95 %RH, storage: 0 to 95 %RH (no freezing or condensation)
Protection structure	IP67 (IEC standard)
Cable spec.	Power I / O cable: Ø 5 mm, 8-wire, 5 m Ethernet cable: Ø 5 mm, 4-wire, 3 m, shield cable, RJ45 connector
Wire spec.	AWG26 (0.16 mm, 7-core), insulator outer diameter: Ø 1 mm
Material	Case: AL, Window: PC

01) Operates as output test mode and outputs obstacle detection output and error status output.

Communication Interface

■ Ethernet

Communication protocol	TCP/IP
Communication speed	100BASE-TX
Baud rate	100 Mbps

Indicators

The operation of indicator not stated in the description is unrelated with the status.

■ Indicator by situation

Status		No.1 (green)	No.2 (red)
Power	ON	ON → OFF (once)	ON → OFF (once)
	Normal operation	ON	-
Comm.	Connection	Flashing	-
	Parameter download	ON → OFF (once)	ON → OFF (once)
Obstacle detection		ON	ON
Output test mode		Flashing	Flashing
Teaching	Preparation	Flashing (for 5 sec)	-
	Progress	-	Flashing (for 60 sec)

■ Error indicator

Status	No.1 (yellow)	No.2
Anti-masking	ON	ON (red)
Background	ON	Flashing (red)
Comm. error	ON	-
Voltage error	Flashing	Flashing (yellow)
Temperature error	Flashing	-
Product problem ⁽⁰¹⁾	Flashing	ON (yellow)

01) Please contact customer service center.

Sold Separately: Bracket

• Unit: mm, For the detailed drawings, follow the Autonics website.

■ Main bracket: BK-LSE3

• Components: M4 × L8 bolt: 4, M4 × L10 bolt: 2

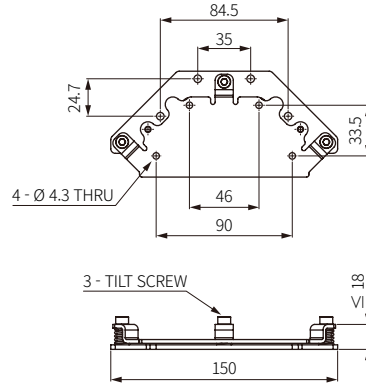

■ Sub bracket: BK-LSE2-SUB

• Components: M4 × L8 bolt: 4

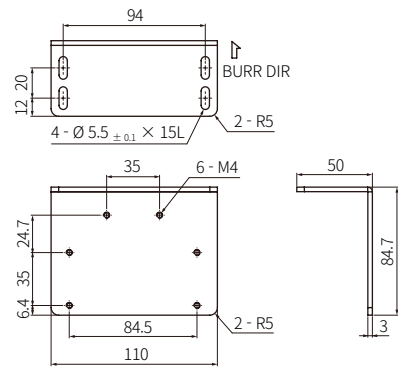

■ Main / sub bracket mounting

The device can be installed according to the desired installation angle by connecting 4 - Ø 4.3 through holes of the main bracket and 4 consecutive M4 holes of the sub bracket.

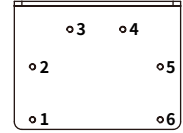

[Sub bracket hole position]

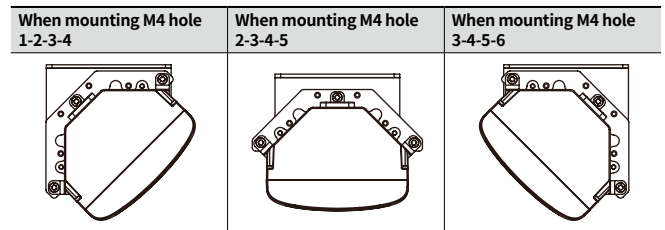

Filter

Filters: Fog, Particle can be applied duplicated depending on the surrounding environment and detection object.

In case of multiple filters applied, 1. Fog filter 2. Particle filter is applied in order.

- When a filter is applied, the output cannot be reverted to the original scan data.

■ Fog filter

Reduces the laser reception sensitivity to avoid detecting fog, rain, and snow to prevent obstacle detection errors.

- Default

LSE3-4A5R2-ET	5
LSE3-4A10R2-ET	2

- Setting range

SV	0	1	2	3	4	5	6	7
Sensitivity	Most sensitive	>>	>	>	>	>	>	Most insensitive

■ Particle filter

It uses continuous scan data to block the measurement of fine objects such as static objects or dust when detecting backgrounds.

- Default: 5
- Setting range

SV	1	2	3	4	5
Level	OFF	Low	<	<<	High

Function

It is set in the LiDAR sensor management software atLiDAR.

For more information, refer to the atLiDAR software manual.

■ Output

Set the output type between obstacle detection output (OUT 1) and error status output (OUT 2).

Obstacle detection output (OUT1)	Error status output (OUT2) ⁰¹⁾
Normally open	Normally open (default)
	Normally closed
	Pulse
Normally closed	Normally open
	Normally closed
	Pulse

01) In case of Pulse of OUT2 (error status output) as ON, it repeats open-close operation for 1 sec at the normal operation and it closes at error status.

■ Field output activation

Set the relay output ON/OFF when detecting an obstacle.

- Default: ON
- Setting range: ON / OFF

■ Activated channel (s)

The laser scanner has 4 channels (Ch1, Ch2, Ch3, Ch4).

Activate the channel (s) for obstacle detection.

Channel	Angle	Default
Ch1	0°	Activated
Ch2	2°	
Ch3	4°	
Ch4	6°	

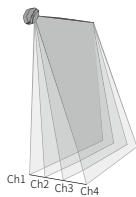

■ Anti-Masking error

An anti-masking error occurs when obstacle detection is not possible due to a foreign object on the front window of the device.

- Default: ON
- Error occurrence condition
 - Anti-masking error occurs when an object is detected within about 15 cm from the front window for more than 3 seconds
- Error clearing condition
 - Anti-masking error is cleared when no object is detected within about 15 cm from the front window for more than 5 seconds

■ Background error

When the initial set reference distance of background teaching data is changed, background error occurs.

- Default: ON
- Error occurrence condition
 - If the reference distance value is changed by 60 cm or more for about 3 seconds or more at one of the initial background teaching values (the reference distance of the scan angle 0 / 45 / 90°), it is determined that the position of the device has changed and a background error occurs.
- Error clearing condition
 - If the reference distance data is within 'reference distance data during teaching + about 30 cm' for longer than about 5 seconds, the background error is cleared.

■ Sensor position

Set the actual installed device position: view (top or bottom) and installation (left, right, or center).

SV	
View	Position
Top	Left
	Center
	Right
Bottom	Left (default)
	Center
	Right

■ Concentrated monitoring zone: W (width) × H (height)

Set the unnecessary area to exclude from the monitoring zone.

- Default: W 0.000 m × H 0.000 m
- Setting range [m]: W 0.000 × H 0.000 to W 0.300 × H 0.300

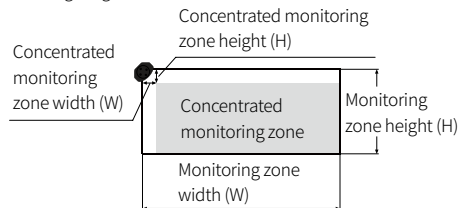

■ Monitoring zone: W (width) × H (height)

By setting the width and height, the monitoring zone of the rectangle can be set.

	LSE3-4A5R2-ET	LSE3-4A10R2-ET
Default	W 4.500 m × H 1.700 m	W 9.000 m × H 1.700 m
Setting range	W 0.001 m × H 0.001 m to W 5.600 m × H 5.600 m	W 0.001 m × H 0.001 m to W 10.000 m × H 10.000 m

■ Teaching

The ability to pre-train field.

Objects within the monitoring zone are not detected while teaching.

- Re-teach when the environment has been changed or objects are added or removed in same area.
- Operate teaching in the environment free from snow, rain, fog, hail, or mutual interference of another laser scanner.
- For re-install the unit teaching already at no teaching required area, set the use of teaching data to OFF.

■ Minimum object size

Set the size of minimum detection object.

Even objects smaller than the set minimum detection object size can be detected depending on the environment.

- Default: 50 mm
- Setting range [mm]: OFF, 50, 100, 150, 200

■ Monitoring time

If there is an object in the field during the set monitoring time, an obstacle detection output is ON.

By setting monitoring time longer, the laser scanner scans field repeatedly and scans obstacles without being affected by snow or rain.

- Default: 100 ms
- Setting range [ms]: 0, 100, 200, 300, 400, 500, 600, 700, 800, 900

■ Visible laser activation

By operating the visible laser, the user can check the area the device scanned by the sensor.

The visible laser activation time can be set in 1 second increments up to 3600 seconds.